

## Standard Triac

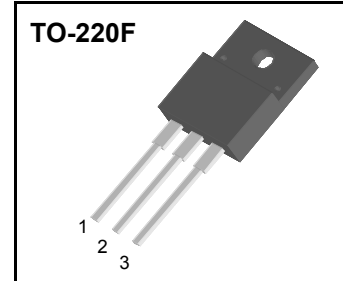
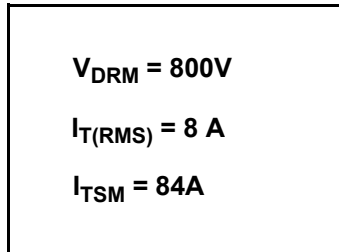
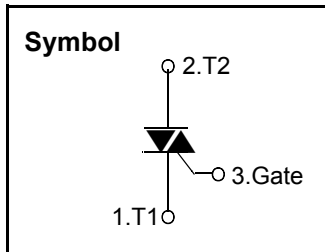

### Features

- ◆ Repetitive Peak Off-State Voltage : 800V
- ◆ R.M.S On-State Current (  $I_{T(RMS)}=8 A$  )
- ◆ High Commutation dv/dt

### General Description

This device is fully isolated package suitable for AC switching application, phase control application such as fan speed and temperature modulation control, lighting control and static switching relay.

### Absolute Maximum Ratings ( $T_j = 25^\circ C$ unless otherwise specified )

Symbol	Parameter	Condition	Ratings	Units
$V_{DRM}$	Repetitive Peak Off-State Voltage	Since wave, 50 to 60Hz	800	V
$I_{T(RMS)}$	R.M.S On-State Current	$T_j = 125^\circ C$ , Full Sine wave	8.0	A
$I_{TSM}$	Surge On-State Current	One Cycle, 50Hz/60Hz, Peak, Non-Repetitive	80/84	A
$I^2t$	$I^2t$	$t_p=10ms$	32	$A^2s$
$P_{G(AV)}$	Average Gate Power Dissipation	$T_j=125^\circ C$	1	W
$I_{GM}$	Peak Gate Current	$T_j=125^\circ C$	2	A
$T_J$	Operating Junction Temperature		- 40 ~ 125	$^\circ C$
$T_{STG}$	Storage Temperature		- 40 ~ 150	$^\circ C$



# TF8A80

## Electrical Characteristics (T<sub>j</sub>=25 °C unless otherwise specified)

Symbol	Items		Conditions	Ratings			Unit
				Min.	Typ.	Max.	
I <sub>DRM</sub>	Repetitive Peak Off-State Current		V <sub>D</sub> = V <sub>DRM</sub> , Single Phase, Half Wave T <sub>j</sub> = 125 °C	—	—	2	mA
V <sub>TM</sub>	Peak On-State Voltage		I <sub>TM</sub> = 11 A, T <sub>P</sub> =380 $\mu$ s	---	—	1.55	V
I <sup>+</sup> <sub>GT1</sub>	I	Gate Trigger Current	V <sub>D</sub> = 12 V, R <sub>L</sub> =30 $\Omega$	—	—	30	mA
I <sup>-</sup> <sub>GT1</sub>	II			—	—	30	
I <sup>-</sup> <sub>GT3</sub>	III			—	—	30	
V <sup>+</sup> <sub>GT1</sub>	I	Gate Trigger Voltage	V <sub>D</sub> = 12 V, R <sub>L</sub> =30 $\Omega$	—	—	1.5	V
V <sub>GT1</sub>	II			—	—	1.5	
V <sub>GT3</sub>	III			—	—	1.5	
V <sub>GD</sub>	Non-Trigger Gate Voltage		T <sub>j</sub> = 125 °C, V <sub>D</sub> = V <sub>DRM</sub> , R <sub>L</sub> =3.3K $\Omega$	0.2	---	—	V
dv/dt	Critical Rate of Rise Off-State Voltage		T <sub>j</sub> = 125 °C, V <sub>D</sub> =2/3 V <sub>DRM</sub>	200	--	--	V/ $\mu$ s
I <sub>H</sub>	Holding Current		I <sub>T</sub> =0.2A	--	--	50	mA



# TF8A80

Fig 1. Gate Characteristics

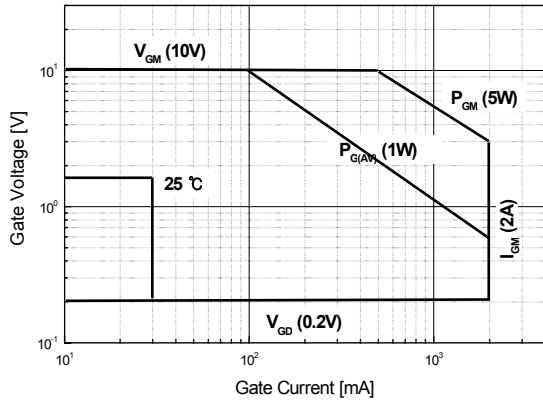

Fig 2. On-State Voltage

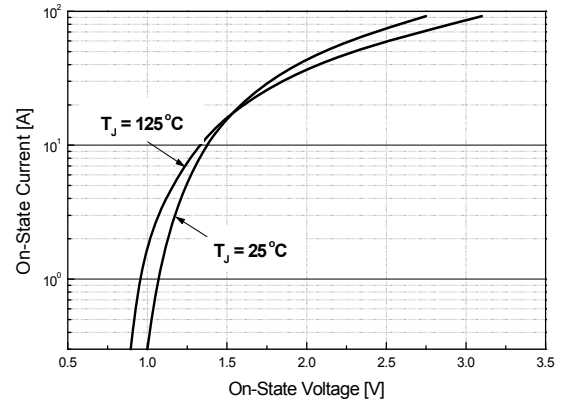

Fig 3. On State Current vs. Maximum Power Dissipation

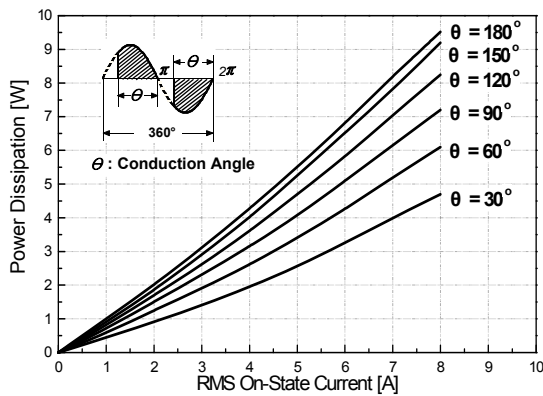

Fig 4. On State Current vs. Allowable Case Temperature

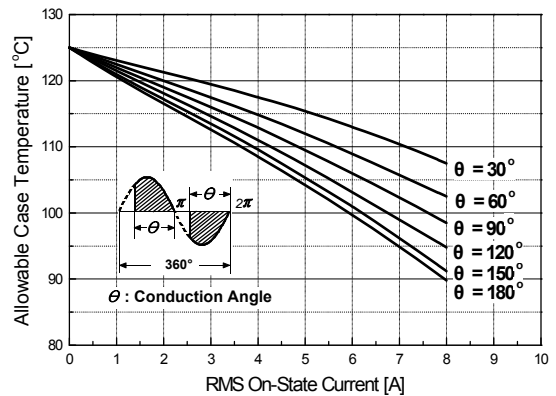

Fig 5. Surge On-State Current Rating ( Non-Repetitive )

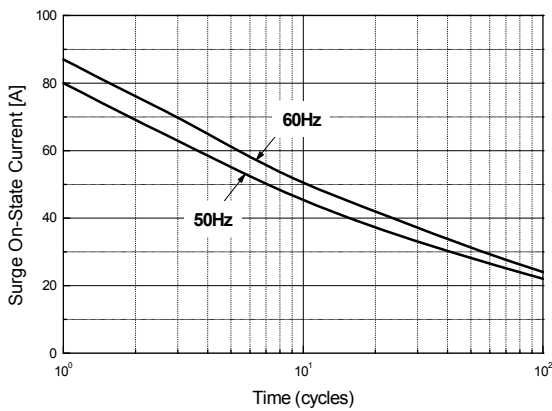
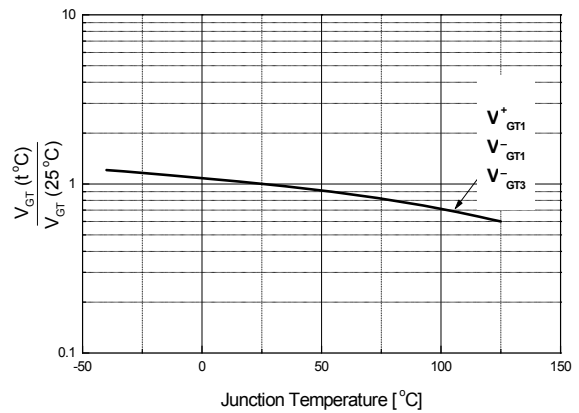
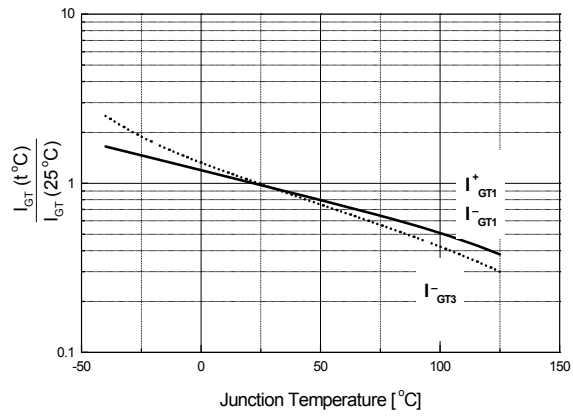

Fig 6. Gate Trigger Voltage vs. Junction Temperature

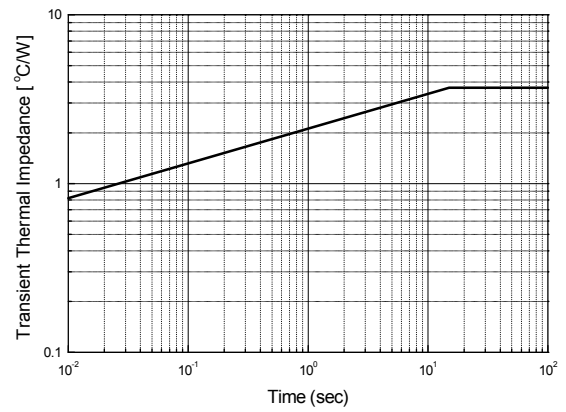



**Fig 7. Gate Trigger Current vs. Junction Temperature**



**Fig 8. Transient Thermal Impedance**





# TF8A80

## TO-220F Package Dimension

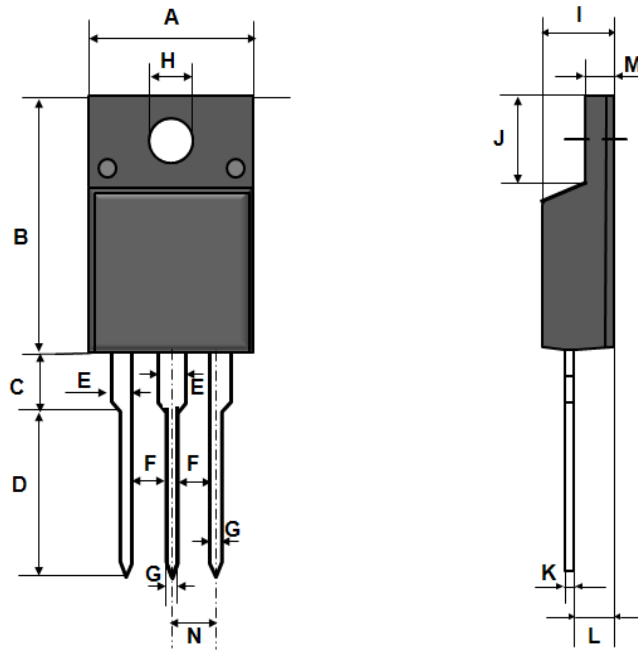

Symbol	INCHES			MILLIMETERS		
	MIN	TYP	MAX		MIN	TYP
A	9.88	10.08	10.28	25.10	25.60	26.11
B	15.30	15.50	15.70	38.86	39.37	39.88
C	2.95	3.00	3.05	7.49	7.62	7.75
D	10.30	10.50	10.70	26.16	26.67	27.18
E	0.95	1.08	1.20	2.41	2.74	3.05
F	1.81	1.84	1.87	4.60	4.67	4.75
G	0.50	0.70	0.90	1.27	1.78	2.29
H	3.00	3.20	3.40	7.62	8.13	8.64
I	4.35	4.45	4.55	11.05	11.30	11.56
J	6.20	6.40	6.60	15.75	16.26	16.76
K	0.41	0.51	0.61	1.03	1.28	1.54
L	2.30	2.50	2.70	5.84	6.35	6.86
M	2.53	2.73	2.93	6.43	6.93	7.44
N	2.34	2.54	2.74	5.94	6.45	6.96



## TO-220F Package Dimension, Forming

Dim.	mm			Inch		
	Min.	Typ.	Max.	Min.	Typ.	Max.
A	10.4		10.6	0.409		0.417
B	6.18		6.44	0.243		0.254
C	9.55		9.81	0.376		0.386
D	8.4		8.66	0.331		0.341
E	6.05		6.15	0.238		0.242
F	1.26		1.36	0.050		0.054
G	3.17		3.43	0.125		0.135
H	1.87		2.13	0.074		0.084
I	2.57		2.83	0.101		0.111
J		2.54			0.100	
K		5.08			0.200	
L	2.51		2.62	0.099		0.103
M	1.23		1.36	0.048		0.054
N	0.45		0.63	0.018		0.025
O	0.65		0.78	0.0025		0.031
P		5.0			0.197	
$\phi$		3.7			0.146	
$\phi 1$		3.2			0.126	
$\phi 2$		1.5			0.059	

